

MULTIMEDIA DATA/VIDEO PROJECTORS

Fan Noise

22dBA

*Long Life Lamp
with lamp low mode*

5000hrs

NEW



Brightness

3100lm



PORTABLE XGA PROJECTOR

XL550U

*Project your presentations with brilliance,
and super-soft fan noise.*

Brightness 3100lm

The Mitsubishi Electric XL550U projects outstanding brightness of 3100lm. Treat the audience to high-caliber images without adjusting the lights, even in classrooms or large lecture halls.



1000lm



3100lm

Fan Noise 22dBA*1

Mitsubishi proudly presents "Quiet Running Design of 22dBA*1," slashing the fan noise level to 1/16th*2 that of our conventional model. Concentrate on presentations free of fan noise concern.

(*1): When used at low lamp mode. (*2): The XL550U reduces fan noise to 22dBA (compared to 34dBA in the conventional model).

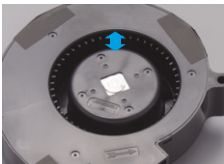

Conventional fan

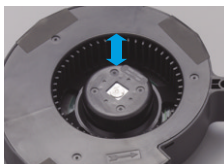

XL550U fan

Long Life Lamp ~ Maximum 5,000 hours

Supported by our optimum design for light source lamp temperature control, maximum light source lamp use soars to 5,000 hours.*1 This makes dramatic reductions in running cost, while likewise slashing replacement hassle for the light source lamp as a consumable part.*2

(*1): When used at the low lamp mode. Maximum lamp life at standard mode use is 2,000 hours. (*2): Lamp life refers to the average time required for brightness to be reduced by half, and not the time specified in the warranty. Use time may vary widely by the environment and conditions, and whether or not cleaning and other maintenance procedures are followed.

Lamp Replacement Frequency*

(*): Lamp life refers to the average time required for brightness to be reduced by half, and not the time specified in the warranty.

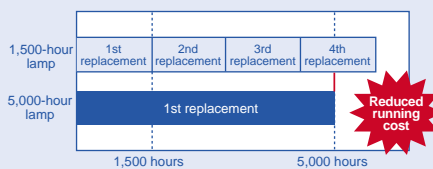

Lamp Side Replacement

The lamp may be removed from the side of the projector unit. This simplifies replacement without turning the projector around or over when suspended from the ceiling or resting on a shelf.

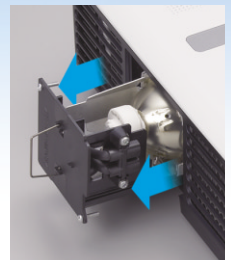

Security Anchor

A robust key-lock chain may be passed through the projector hook. This reliable anti-theft measure helps prevent unauthorized removal of the projector unit from the premises.



Note: Mitsubishi Electric cannot accept responsibility for thefts occurring despite use of this safety feature.



NEW PORTABLE XGA PROJECTOR **sRGB**
XL550U

Input and Output Terminals

Enhanced terminal group realizes a versatile range of presentations.

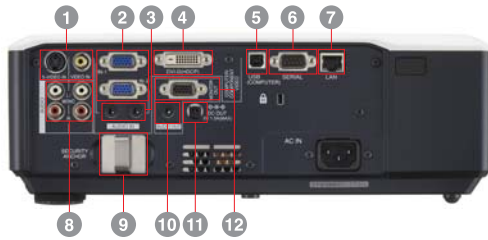

- ① S-Video / Video input
- ② PC / Component Video input(mini D-sub 15pin)
- ③ PC / Audio input
- ④ DVI-D(with HDCP) input
- ⑤ USB terminal for mouse control
- ⑥ Serial RS-232C(D-sub 9pin)
- ⑦ LAN(RJ-45)
- ⑧ Video / Audio input
- ⑨ Security Anchor
- ⑩ Audio output
- ⑪ DC Out 5V 1.5A(Max)
- ⑫ Monitor output

Specifications

Model	XL550U
Display technology	0.8"3-LCD(with Micro Lens)
Resolution	1024×768(total 786,432 pixels), 600video lines
Brightness	3100lm
Contrast	400 : 1(on/off)
Projection lens	f=24-29mm, F1.7-1.9
Picture Size	40"~300"(100"=3.0~3.6m)
Source lamp	160W (Shut Off Time 5000Hrs) with Low Mode 200W (Shut Off Time 2000Hrs)
Computer compatibility	640×480~1600×1200 True: 1024×768, Sync on green available
Video compatibility	NTSC/NTSC4.43/PAL(including PAL-M, N)/SECAM/PAL-60, Component Video: 480i/p(525i/p),576i/p(625i/p),720p (750p 50/60Hz),1080i(1125i 50/60Hz),SCART(RGB+1V sync)
PC input terminals	PC: mini D-sub 15pin×2, DVI-D(with HDCP)×1, Audio: stereo mini (φ3.5)×2
Video input terminals	Video: RCA×1, S-video×1, Audio: RCA (L,R)×2
Output terminals	Monitor Out: mini D-sub 15pin×1, DC Out: 5V 1.5A(MAX) Audio: stereo mini(φ3.5)×1
Communication terminals	LAN(RJ-45)×1,RS-232C(D-Sub 9 pin)×1, USB terminal for mouse control×1
Audio speaker	3W mono
Dimension (W×H×D)	333×113×272mm (excluding height adjustment)
Weight	4.5kg / 9.9lbs
Power supply	AC100 - 240V, 50/60Hz
Optional lamp	VLT-XL550LP

*All brand names and product names are trademarks, registered trademarks or trade names of their respective holders.

Dimensions

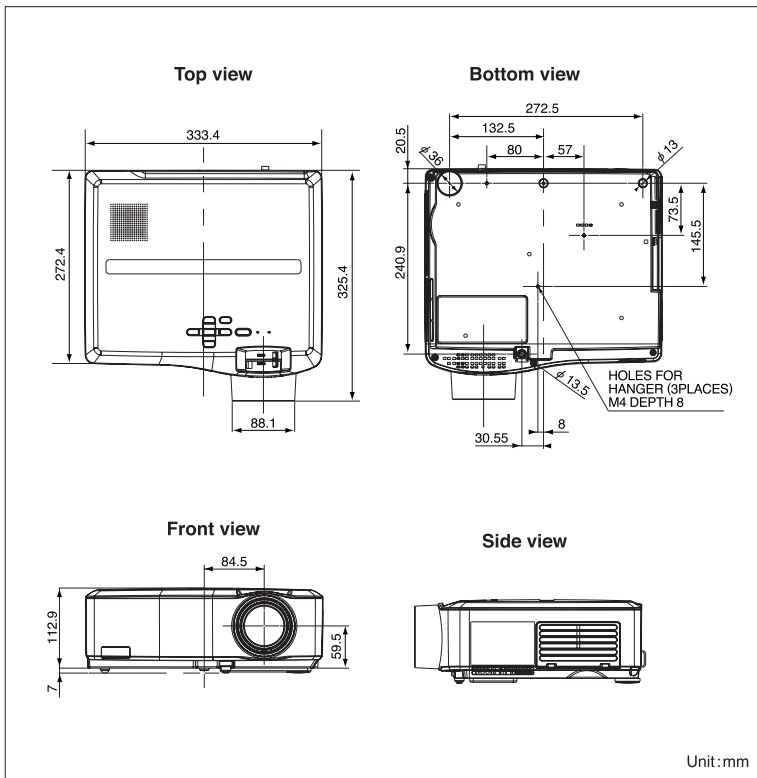

Screen size and Projection distance

As seen from the side

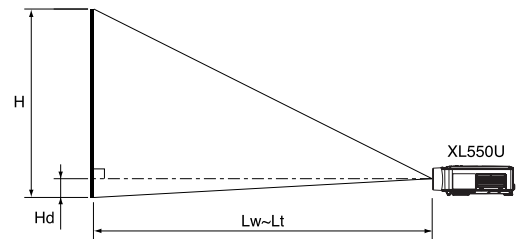

Screen size chart (4:3 aspect ratio)

Diagonal size		Screen		Distance from screen (L)				Height projected image (Ha)	
inch	cm	Width (W)	Height (H)	Maximum Zoom	Minimum Zoom			inch	cm
40	102	32	24	46	1.2	56	1.4	2.4	6
60	152	48	36	70	1.8	85	2.2	3.6	9
80	203	64	48	94	2.4	114	2.9	4.8	12
100	254	80	60	122	3.0	142	3.6	6.0	15
150	381	120	90	177	4.5	215	5.5	9.0	23
200	508	160	120	237	6.0	287	7.3	12.0	31
250	635	200	150	297	7.5	359	9.1	15.0	38
300	762	240	180	357	9.1	-	-	18.0	46

The above numbers are approximate, and may be slightly different from the actual measurements.

Option



Lamp
VLT-XL550LP

MITSUBISHI ELECTRIC CORPORATION
HEAD OFFICE : TOKYO BLDG., 2-7-3, MARUNOUCHI, CHIYODA-KU, TOKYO 100-8310, JAPAN

To find out more about XL550U and our projectors, visit us at

Global.MitsubishiElectric.com/projectors/